

2.3 - 2.5 GHz 1W MMIC

FEATURES

- P₋₁ dB: 30 dBm
- Small Signal Gain: 26 dB
- Power Added Efficiency: 32 %
- IP3: 40 dBm
- Matched to 50 Ω operation
- Bias condition: 400 mA @ 7 V

PHOTO ENLARGEMENT



DESCRIPTION

The TC3139 is a 2 stage PHEMT MMIC power amplifier. It is designed for use in low cost, high volume, 2.3 –2.5 GHz band applications. The MMIC provides a typical gain of 26 dB and P_{1dB} power of more than 30 dBm. Typical bias condition is 7V at 400 mA. The MMIC is packaged in a low-cost surface-mountable plastic package. The input and output matching of the MMIC require minimum external components.

APPLICATIONS

- Wireless Internet Access
- Wireless Local Loop
- Two way radio

ELECTRICAL SPECIFICATIONS (T_a = 25 °C)

SYMBOL	DESCRIPTION	MIN	TYP	MAX	UNITS
FREQ	Frequency Range	2.3		2.5	GHz
SSG	Small Signal Gain	25	26		dB
GOF	Small Signal Gain Flatness		±0.5	±0.75	
P₋₁ dB	Output Power at 1 dB Gain Compression	29	30		dBm
P₋₃ dB	Output Power at 3 dB Gain Compression	30	31		dBm
IP3	Third Order Intercept Point	38	40		dBm
VSWR, IN	Input VSWR		2:1		
VDD	Supply Voltage		7		Volt
Vg	Gate Voltage	-0.6	-1.0	-1.5	Volt
IDD	Current Supply Without RF		400		mA
IDP₋₁	Current Supply @ P _{out} =P ₋₁ dB		450		mA
η_a	Power Added Efficiency		32		%

TEST CIRCUITS

Evaluation Board Schematic

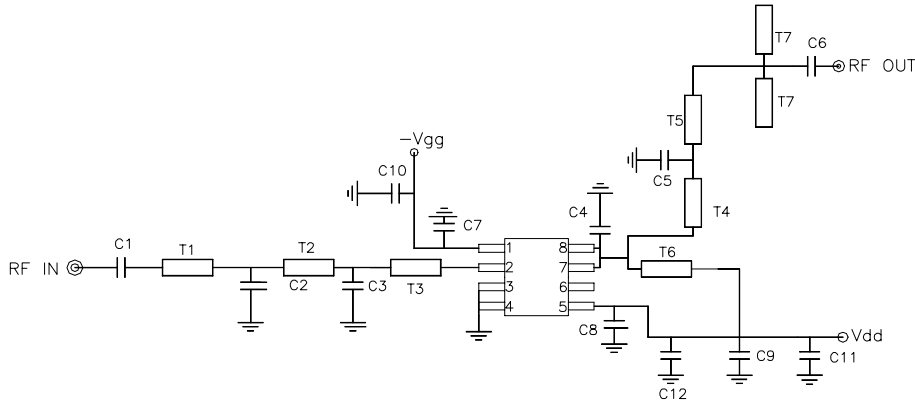

EVALUATION BOARD

DXF file of the PCB can be downloaded from our web-site at www.transcominc.com.tw

PCB Material: FR4
 ER = 4.6
 Thickness = 32 mil
 Unit: mil

Application Notes:

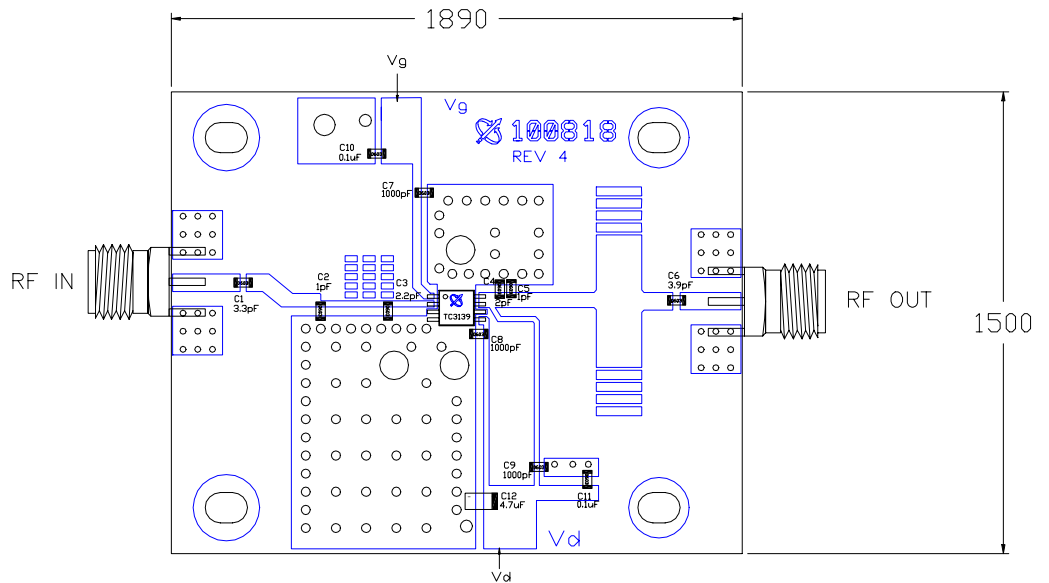
For better heat sinking and grounding, it's recommended to have the via holes beneath TC3139 filled with solder and have two screws besides TC3139 installed on the PCB area.



Evaluation Board Parts List

Part Type	Reference Designator	Description	Manufacturer	Part Number
Capacitor	C1	3.3 pF 0603	Murata	GRM39C0G3R3C50V
Capacitor	C2, C5	1 pF 0603	Murata	GRM39C0G101C50V
Capacitor	C3	2.2 pF 0603	Murata	GRM39C0G2R2C50V
Capacitor	C4	2 pF 0603	Murata	GRM39C0G020C50V
Capacitor	C6	3.9 pF 0603	Murata	GRM39C0G3R9C50V
Capacitor	C7~9	1000 pF 0603	Murata	GRM39C0G102J50V
Capacitor	C10, C11	0.1 uF 0603	Murata	GRM39Y5V104Z25V
Capacitor	C12	4.7uF Tantalum Cap.		

CONNECTION DIAGRAM AND PIN DESCRIPTIONS

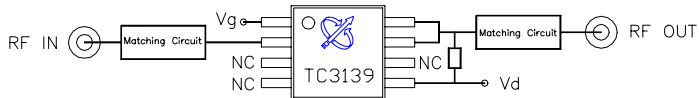

Pin #	Name	Description
2	RF IN	RF input
5	V _d	MMIC drain bias
1	V _g	MMIC gate bias
7, 8	RF OUT	RF output
Others	NC	No Connection

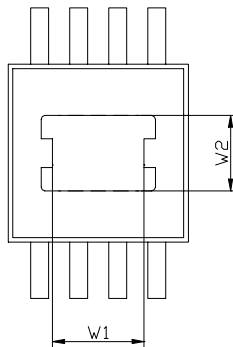
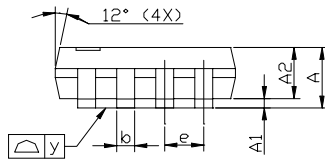
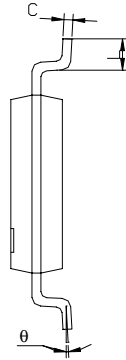
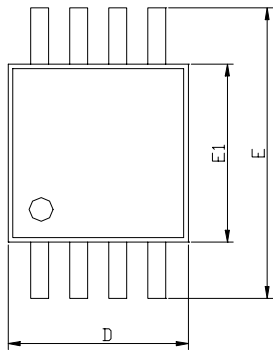
PHYSICAL DIMENSIONS (Unit: inches)

SYMBOLS	DIMENSIONS IN INCHES		
	MIN	NOM	MAX
A	0.032	0.0375	0.043
A1	0.002	0.0035	0.005
A2	0.030	0.034	0.038
b	0.011	0.012	0.015
C	0.005	0.006	0.009
D	0.114	0.118	0.122
E	0.185	0.193	0.201
E1	0.114	0.118	0.122
e	---	0.026	---
L	0.016	0.021	0.026
y	---	---	0.004
θ	0°	---	6°
W1	0.045	---	0.075
W2	0.035	---	0.065